

# DML2000

Improve the ergonomics of your dual monitor setup with DML2000. Supporting monitors up to 27", this fully adjustable desktop stand enables positioning of your monitors for improved posture and productivity. Monitor height is achieved with a toolless lever that allows for on-the-fly height adjustments while a micro height adjust feature allows your monitors to be perfectly aligned. To make deployment a snap, the detachable VESA monitor plate gives you the freedom to attach and remove your monitor quickly and easily. This stand can be attached to any desk with its included desk clamp or grommet mount and cable management pathways are provided to keep your workspace distraction free.

## FEATURES & SPECIFICATIONS

- Fits most computer monitors from 17" to 27"
- Supports monitors weighing up to 22.1 lb (10 kg)
- Accommodates VESA sizes of 75x75 and 100x100
- Accessible tilt mechanism provides +90° to -80° of tilt
- 180° of swivel
- Each arm provides up to 14.7" (37.4 cm) of reach
- Height adjustable between 5.1" (13 cm) and 16.7" (42.5 cm) depending on screen size
- 360° monitor rotation for vertical and horizontal screen orientation
- Cable management hooks included
- Hardware for desk clamp and grommet installation is included
- Painted steel and plastic construction with powdercoat finish
- User manual and all monitor mounting hardware included
- Five year manufacturer's warranty
- Shipping box weight: 11.7 lb (5.3 kg)
- Shipping box dimensions: 20.3" x 9.8" x 4.7" (51.5 x 25 x 12 cm)
- Product weight: 10.8 lb (4.9 kg)
- UPC: 800152721071

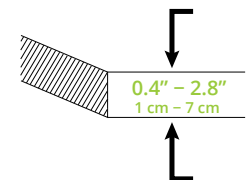
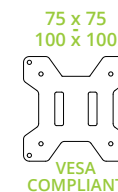
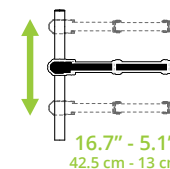
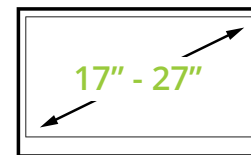

## TECHNICAL ILLUSTRATIONS

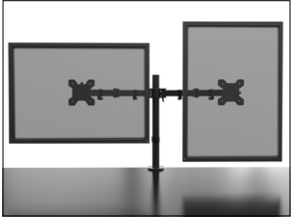

### IMPROVED ERGONOMICS

Featuring tilt, swivel, and 360° monitor rotation to support portrait or landscape orientations, DML2000 allows you to position your dual monitors to improve workplace ergonomics and line-of-sight.



### ON-THE-FLY ADJUSTMENTS

A toolless lever allows easy on-the-fly height adjustments – useful for shared workspaces that accommodate various users. A micro height adjust feature is included to ensure monitor alignment.



### EASY DEPLOYMENT

The detachable VESA monitor plate lets you to work on a flat surface instead of supporting your monitor during installation. The plate easily slides onto the stand and can be removed quickly for servicing.



### CLEAN AESTHETICS

Included cable management hooks keep wires tidy for a professional look and reduces distractions in the workspace.

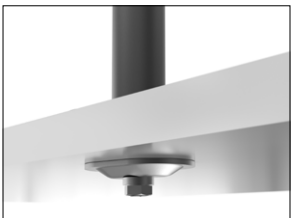

### UNIVERSALLY COMPATIBLE

The DML2000 supports dual 27" monitors weighing up to 22.1 lbs each. The stand can be clamped to nearly all desks from 0.4" to 2.8" thick and includes hardware for desk grommet installation.

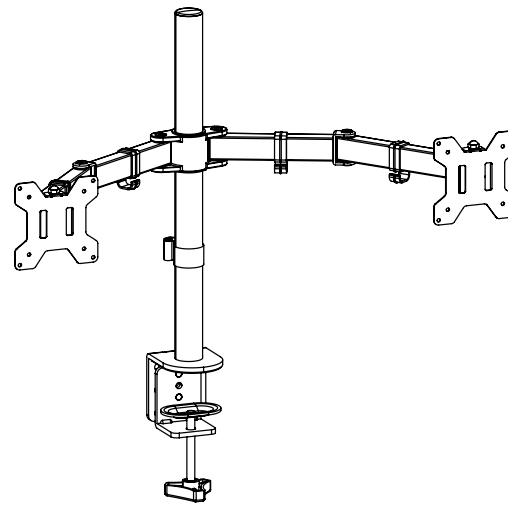

DETACHABLE MONITOR PLATE

