

*English*

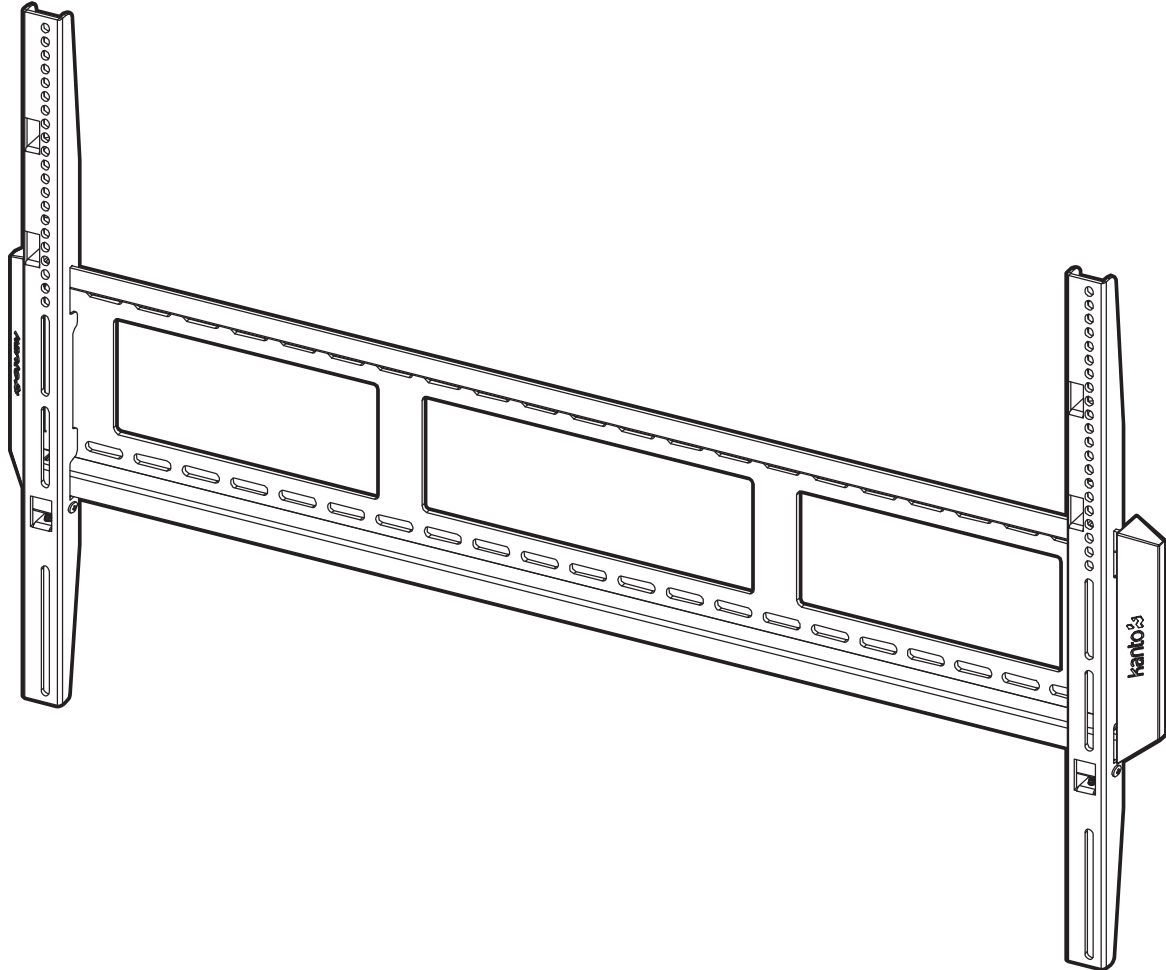

# User Manual

F6080 TV Mount



## FIXED FLAT PANEL TV MOUNT

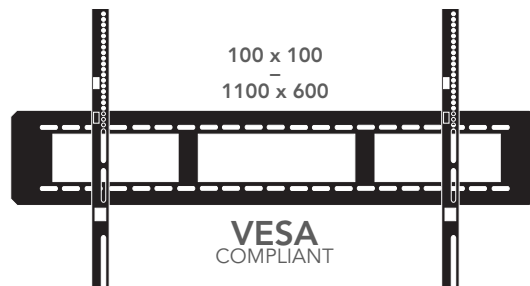
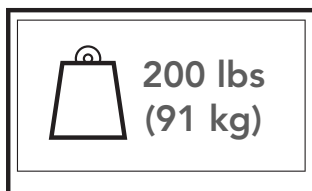

# Table of Contents

Table of Contents / Introduction	2	Setup - Steps 3 to 4	6
Supplied Parts & Hardware	3	Other Kanto Products	7
Setup - Step 1	4	Warranty	8
Setup - Step 2	5		

## Introduction

Thank you for choosing a Kanto Living wall mount. The F6080 is designed to mount flat panel televisions weighing up to 200 lbs (91 kg) within 1" of your wall.

Read these instructions fully before installation of this mount. If you do not understand these directions, or have any doubts about the safety of the installation, please consult a qualified installation contractor to install this mount. Make sure there are no defective or missing parts. Do not use defective parts. If you are uncertain whether the part is defective call Kanto Living directly at 1-888-848-2643 or [support@kantoliving.com](mailto:support@kantoliving.com). This product should not be mounted on steel stud walls or cinder block walls. Kanto cannot be liable for property damage or injury caused by incorrect mounting, incorrect assembly, lifting or incorrect use of this product.



See installation video online at:  
[www.kantoliving.com](http://www.kantoliving.com)

 Visit our website at [kantoliving.com](http://kantoliving.com) for the most recent version of this manual

 **CAUTION**  
The maximum loading weight is 200 lbs (91 kg). This wall mount is intended for use only within the maximum weight restrictions indicated. Use with products heavier than the maximum weights indicated may result in instability causing possible injury.

 **CAUTION**  
The wall you plan to affix the Kanto mount to must be able to support more than 5 times the weight of the television and the wall mount combined. Do not use this product for any purpose other than to mount a flat panel TV on a vertical surface as outlined in this manual. Improper installation may cause damage to your TV or serious injury. This product should not be mounted to steel stud walls, cinder block or old concrete walls. Consult a qualified installation contractor if you are unsure about the type of wall you may have.

# Supplied Parts and Hardware

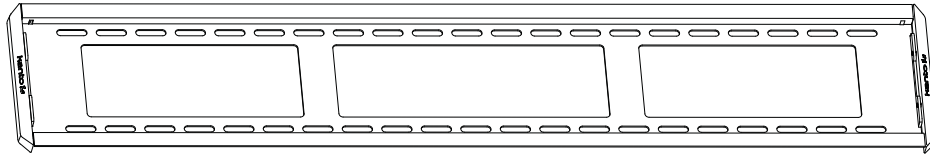

Wall Plate



**x4**

A: M5 x 15mm Bolt

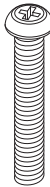

**x4**

B: M5 x 25mm Bolt

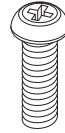

**x4**

C: M6 x 15mm Bolt

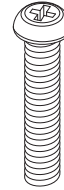

**x4**

D: M6 x 25mm Bolt

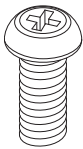

**x4**

E: M8 x 20mm Bolt

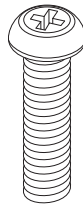

**x4**

F: M8 x 35mm Bolt

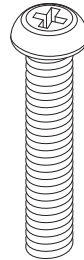

**x4**

G: M8 x 50mm Bolt

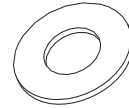

**x4**

H: Washer

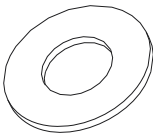

**x6**

I: Lag Bolt Washer

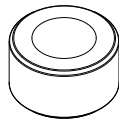

**x4**

J: 5mm



**x4**

K: 10mm

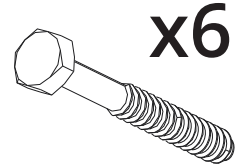

**x6**

L: Lag Bolt

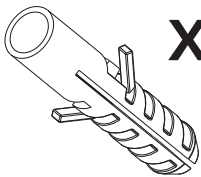

**x6**

M: Concrete Anchor

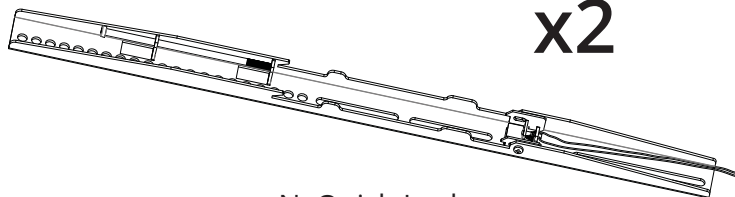

**x2**

N: Quick-Lock TV Bracket

## Required Tools



Socket Set



Phillips Screwdriver



Hammer (for Concrete installs)



Pencil



Stud Finder

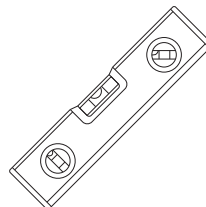

Level

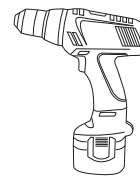

Drill



7/16" Masonry Bit



3/16" Wood Bit

# Step 1: Attach TV Brackets

There are a wide variety of TVs available offering an assortment of bolt sizes. We provide a selection of mounting bolts to fit most TVs. If you have any concerns about this mounting hardware or installation call us direct at 1-888-848-2643 or email at [support@kantoliving.com](mailto:support@kantoliving.com).

## Step 1.1 Select the correct size of bolt

Kanto provides 3 bolt diameters (Metric sizes M5, M6 and M8) in various lengths.

Part items: **A, B, C, D, E, F** or **G**.

Select the correct diameter bolt and hand tighten into the back of the TV to determine the correct length. Use the longest available bolt without reaching the bottom of the TV threads.

If your TV has a curved back, you can use the spacers (**J, K**).

## Step 1.2 Attach TV Bracket Arms to the back of the TV

Now that you have selected the correct bolt size, attach the arms (**O**) to the TV, as shown in Diagram A.

Use the washer (**H**) for bolts **A-D** (sizes M5 and M6). The washer will work for all bolt sizes.

The washer is not required for M8 size bolts (**E, F & G**).

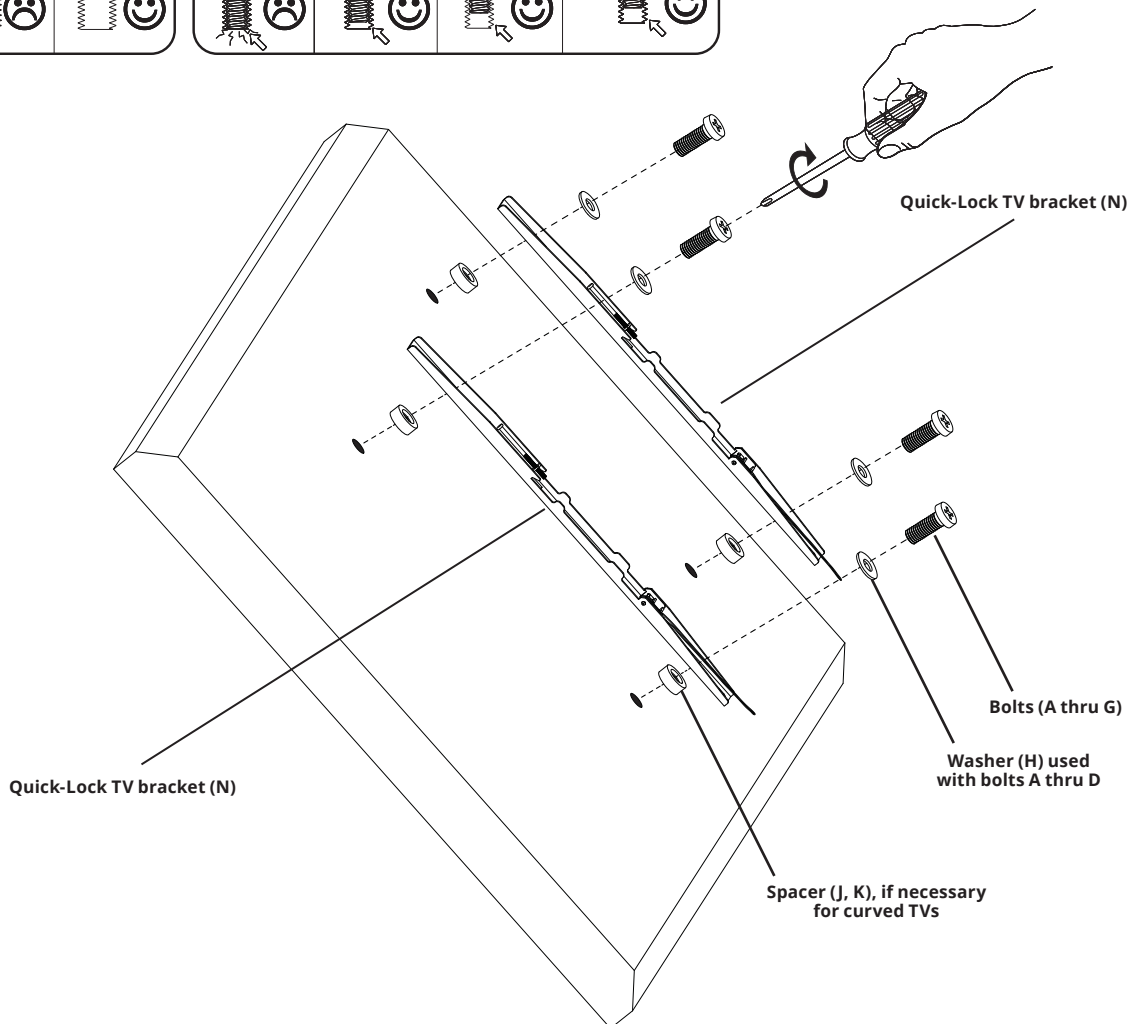
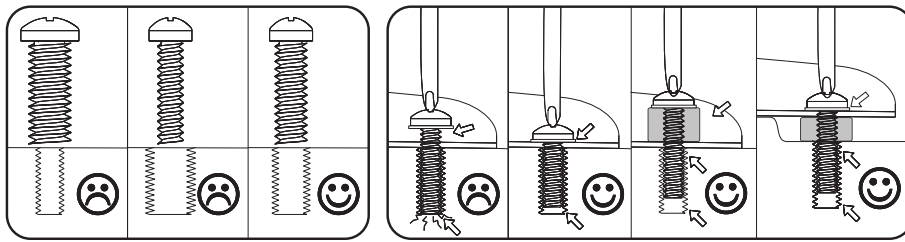

Diagram A



### WARNING

Never over-tighten a bolt into the back of your flat panel TV. Do not lay the TV face down on its glass front. Use a TV stand or lean against a wall.

## Step 2: Mount Wall Plate

### Wood Stud Wall

The Wall Plate can be mounted to three wood studs with 16" centers, or to two wood studs with 24" centers. Use a stud sensor to locate the studs, clearly marking the outer edges of the studs. Use a long level to ensure the holes are level at the desired height.

Pre-drill the upper holes in the center of your studs, and attach the Wall Plate to the wall using Lag Bolts (**L**) and Lag Bolt Washers (**I**) (see Diagram B for three stud installation - we recommend you center the plate if you have two 24" studs). Do not over-tighten lag bolts (**L**). Make sure the Wall Plate is flat against the wall surface. Using the Wall Plate as template, pre-drill the bottom holes, and secure using Lag Bolts (**L**) and Lag Bolt Washers (**I**), taking care not to over-tighten.

### Brick or Concrete Wall

Using the Wall Plate as a template, mark six holes (four toward the outer edge of the Wall Plate and two near the center) at your desired height (see Diagram C). Adjust the Wall Plate position to be clear of mortar joints, keeping in mind that the mount provides minor horizontal shift along the length of the Wall Plate. Use a long level to ensure the six holes are level and at the desired height.

Pre-drill six holes perpendicular to the wall, and insert a Concrete Anchor (**M**) into each of the holes flush with the concrete wall surface and not flush with the surface covering, such as drywall.

Attach the Wall Plate using 6 Lag Bolts (**L**) and Lag Bolt Washers (**I**) (see Diagram C). Make sure the Wall Plate is flat against the wall surface. Do not over-tighten Lag Bolts (**L**).

### Wood

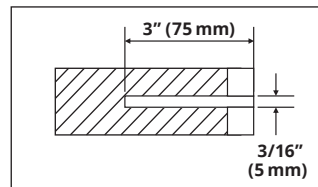

### Concrete

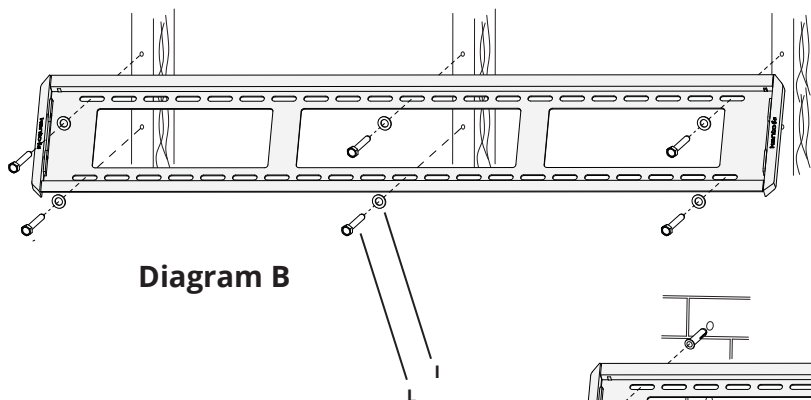
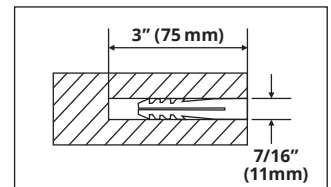

Diagram B

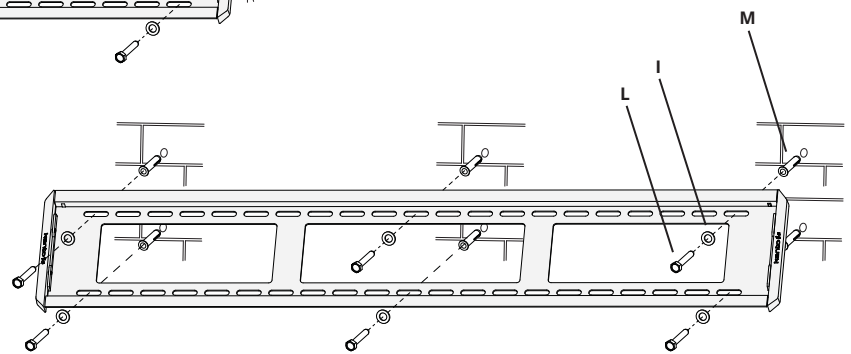

Diagram C



#### CAUTION

Make sure the supporting surface will support the load limits outlined in the Caution at bottom of page two. Tighten Lag Bolts until the Wall Plate is snug flat against the wall. Do not over tighten Lag Bolts (L). Each Lag Bolt must be located in the center of a wood stud.



#### CAUTION

Make sure the concrete or brick wall is at least 3.5" thick. Make sure the anchor is seated completely flush with the concrete surface even if there is another layer of material, such as drywall. If drywall is over 5/8" thick custom lag bolts must be used. Concrete must be a minimum of 2000psi in density.

### Step 3: Attach TV to Wall Plate



#### CAUTION

Read this section carefully prior to install.

With the TV Brackets firmly secured to the TV, use two people to lift the TV into position and hook the TV brackets onto the Wall Plate, as shown in Diagram D. The two spring loaded Quick-Lock Brackets will snap into place as you lower the bottom of the TV onto the plate.

For minor level adjustment, you can adjust the two top Leveling Screws using a Phillips screwdriver to ensure the TV hangs level, as shown in Diagram E. If you need to release pressure on the screws, pull down slightly on the Quick Release cords as shown in Diagram E.

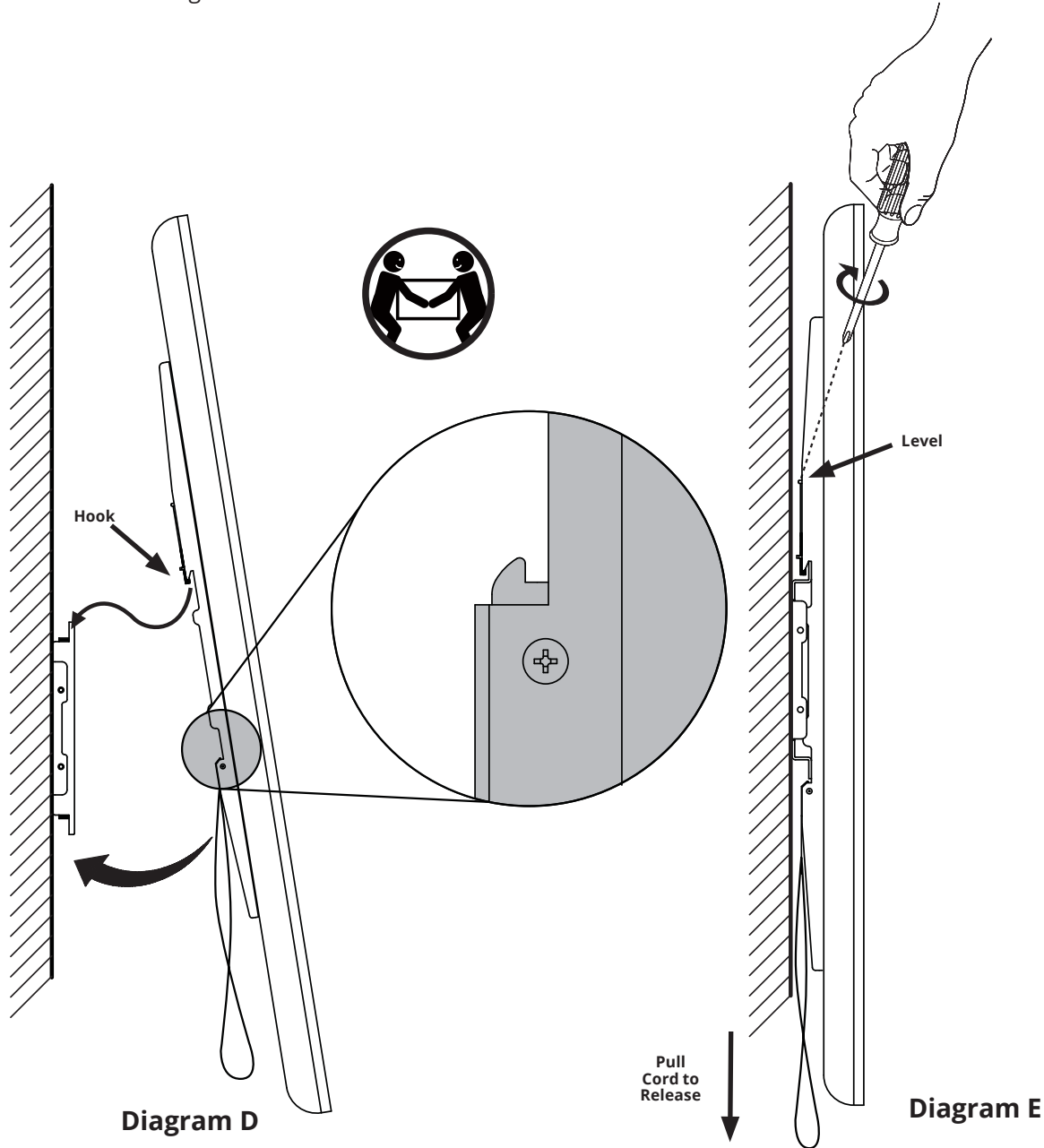

### Step 4: Release the TV

Because the TV sits so close to the wall, the Quick-Lock TV Brackets are equipped with Quick Release Cords. You may need to loosen the top Leveling Screws slightly to release tension. Pull down on the cords to release both Quick-Locks (as shown in Diagram E), and pull the bottom of the TV away from the wall. Then, using two people, lift the TV up and away from the Wall Plate.



#### WARNING

Use two people to lift and position the TV onto the Wall Plate.

# Kanto Speakers

- Check out our full line of bookshelf and desktop speaker systems
- Available in a stunning array of colors
- Visit [kantospeakers.com](http://kantospeakers.com) for more!

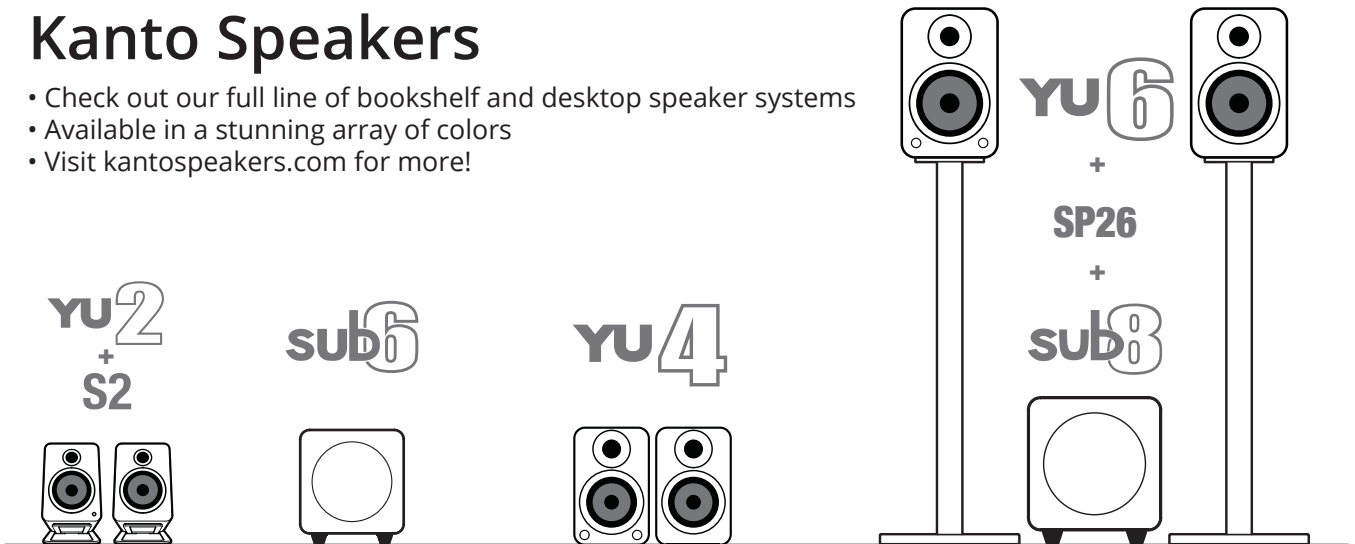

**link**  
par kanto

- Full line of Audio and Video Cables
- White or Black Cables available
- HDMI, Optical, Mini-jack, RCA, USB
- Switchers, Hubs, and Adapters
- Visit [kantoliving.com](http://kantoliving.com)



To learn more about all our products, visit [www.kantoliving.com](http://www.kantoliving.com)

f Kanto Living

🐦 @kantoliving

📷 kantoliving

▶ Kanto Living

📺 Kanto Living

# Warranty

## Limited Warranty to Original Purchaser

Kanto Distribution Inc. (Kanto) warrants the equipment it manufactures to be free from defects in material and workmanship for the following limited warranty period of: 5 years parts and labour

If equipment fails because of such defects and Kanto or an authorized dealer is notified within 5 years from the date of shipment with proof of original invoice, Kanto will, at its option, repair or replace the equipment, provided that the equipment has not been subjected to mechanical, electrical, or other abuse or modifications. Equipment that fails under conditions other than those covered will be repaired at the current price of parts and labor in effect at the repair. Such repairs are warranted for 90 days from the day of reshipment to the original purchaser. This warranty is in lieu of all other warranties expressed or implied, including without limitation, any implied warranty or merchantability or fitness for any particular purpose, all of which are expressly disclaimed. Customers will be responsible for obtaining a Return Authorization as well as shipping costs to return product to a Kanto location or authorized depot listed on the website. If the equipment is covered under the warranty provisions above, Kanto will repair or replace, and be responsible for return shipping to the customer. Please keep the original packaging so products will not be damaged during shipping, and we recommend you insure your shipment. If equipment fails outside the warranty provisions, customers will be quoted repair and return shipping costs prior to work being performed.

The information in the owner's manual has been carefully checked and is believed to be accurate. However, Kanto assumes no responsibility for any inaccuracies that may be contained in the manual. In no event will Kanto, be liable for direct, indirect, special, incidental, or consequential damages resulting from any defect or omission in this manual, even if advised of the possibility of such damages.