

# FACTOR

— ELECTRONICS —

PREMIUM **AUDIO** VIDEO AND **POWER** PRODUCTS

## X-7240-4 & X-7120-4 Four Zone Commercial Mixer Amplifiers

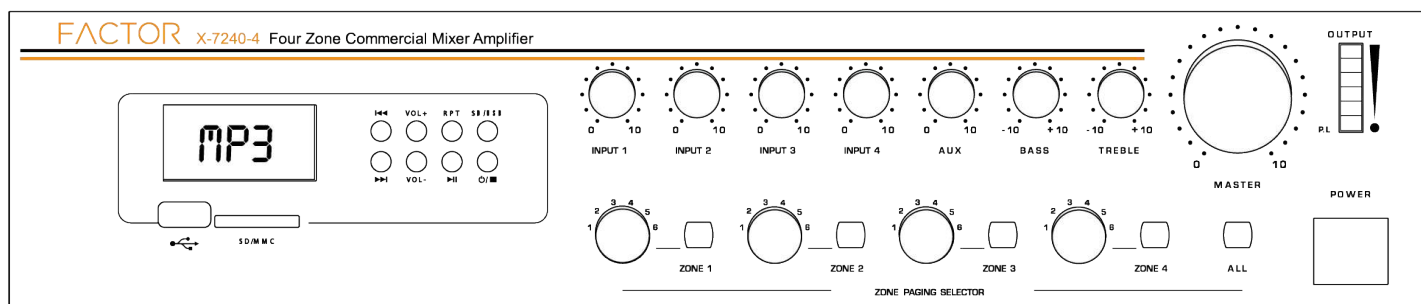

## Owners Manual

**IMPORTANT NOTE:** THIS OWNER'S MANUAL IS PROVIDED AS AN INSTALLATION AND OPERATING AID. FACTOR ELECTRONICS DOES NOT ASSUME ANY RESPONSIBILITY AS TO ITS ACCURACY AND SHALL NOT BE LIABLE IN TORT OR CONTRACT FOR ANY DIRECT, CONSEQUENTIAL OR INCIDENTAL LOSS OR DAMAGE ARISING FROM THE INSTALLATION, USE OR INABILITY TO USE THIS PRODUCT.

**WARNING:** TO REDUCE THE RISK OF FIRE OR ELECTRIC SHOCK DO NOT EXPOSE THIS APPLIANCE TO WATER, RAIN OR MOISTURE. THIS APPLIANCE SHOULD NOT DAMPENED BY WATER DROPS OR SPLASHING. CONTAINERS OF LIQUID SUCH AS VASES SHOULD NOT BE PLACED ON THIS APPLIANCE.

Immediately upon receipt, inspect the unit and shipping container for indications of improper handling or in-transit damage. This equipment was carefully inspected and tested before leaving the factory. Notify the Transportation Company, Wholesaler or Retailer immediately if any damage is found. Be sure to save the carton and packing material as evidence of damage for later inspection. DO NOT SHIP the unit back to the factory unless authorized to do so by the factory. IN TRANSIT DAMAGES ARE NOT COVERED BY THE WARRANTY. **DO NOT INSTALL OR ATTEMPT TO OPERATE THIS UNIT IF IT HAS BEEN DAMAGED.**

#### IMPORTANT SAFETY INSTRUCTIONS

- Read and keep these instructions.
- Heed all warnings and follow all instructions contained within this manual.
- Do not use this unit near water.
- Clean only with dry cloth.
- Do not block any ventilation openings. Install in accordance with the manufacturer's instructions.
- Do not install near any heat sources such as radiators, heat registers, stoves, or other apparatus (including amplifiers) that produce heat.
- Do not defeat the safety purpose of the polarized or grounding-type plug. A polarized plug has two blades with one wider than the other. A grounding type plug has two blades and a third grounding prong. The wide blade or the third prong are provided for your safety. If the provided plug does not fit into your outlet, consult an electrician for replacement of the obsolete outlet.
- Protect the power cord from being walked on or pinched particularly at plugs, convenience receptacles, and the point where they exit from the apparatus.
- Only use attachments/accessories specified by the manufacturer.
- Unplug this apparatus during lightning storms or when unused for long periods of time.
- Refer all servicing to qualified service personnel. Servicing is required when the apparatus has been damaged in any way, such as when the power-supply cord or plug is damaged, liquid has been spilled or objects have fallen into the apparatus, the apparatus has been exposed to rain or moisture, does not operate normally, or has been dropped.
- Operate the product only with the voltage specified on the unit. Fire and/or electric shock may result if a higher voltage is used.
- Do not modify, kink, or cut the power cord. Do not place the power cord in close proximity to heaters and do not place heavy objects on the power cord and/or the product itself, doing so may result in fire or electrical shock.
- Replace the protective cover over the speaker terminals after installation. Do not touch the 70V speaker terminals as electric shock may result.
- Ensure that the safety ground terminal is connected to a proper ground. Never connect the ground to a gas pipe, as a severe explosion and/or fire may result.
- Be sure the installation of this product is stable, avoid slanted surfaces as the product may fall and cause injury, property damage, electrocution and/or fire.
- Note when the unit is turned off it is not completely disconnected from the wall AC power outlet. Do not open the cover unless the device is unplugged from the wall AC power outlet.

## Introduction

Congratulations and thank you for purchasing Factor Electronics products. The Factor Electronics X-Series mixer amplifiers are designed and built to provide ultra reliable performance for professional background music and paging applications. Factor Electronics X-Series amplifiers feature a front panel MP3 player equipped with USB and SDD card inputs, ultra low noise components, flexible expansion options with the V-RVC-PRO and X-Music accessories. Please read this entire manual to get the most from your Factor Electronics X-Series mixer amplifier.

## Unpacking

The X-Series mixer amplifiers include the following parts:

- 1 x X- Series Mixer Amplifier
- 1 x 2U Rack Mounting Kit
- 1 x AC Mains Power Cord
- 1 x Product Manual

**Quick Start:** To get up and running quickly refer to DIAGRAM A on the next page.

- 1.** Connect an iPod, CD player or other music source to the rear panel AUX input jack using a 3.5mm to RCA or RCA-RCA stereo cord.
- 2.** Connect a 70V transformer coupled speaker to the back panel 70V output terminal. Wire the – or negative to the “C” common output terminal and the + or positive to the 70V output terminal. Never connect a 4ohm or 8ohm speaker directly to the 70V output terminal. Always insure the speaker is coupled to a 70V transformer.
- 3.** Once all your audio connections are made, plug in the AC power cord to an AC110V 60 Hz power outlet.
- 4.** Press the front panel power button to the ON position.
- 5.** Adjust the front panel AUX volume knob by turning to achieve the desired volume level.
- 6.** Adjust the front panel MASTER volume knob by turning to achieve the desired volume level.

**Refer to Diagram A on the next page:**

# Quick Start Guide Diagram A

2 Connect a transformer coupled 70V speaker to the C and 70V terminals

1 Connect a music source to the AUX input

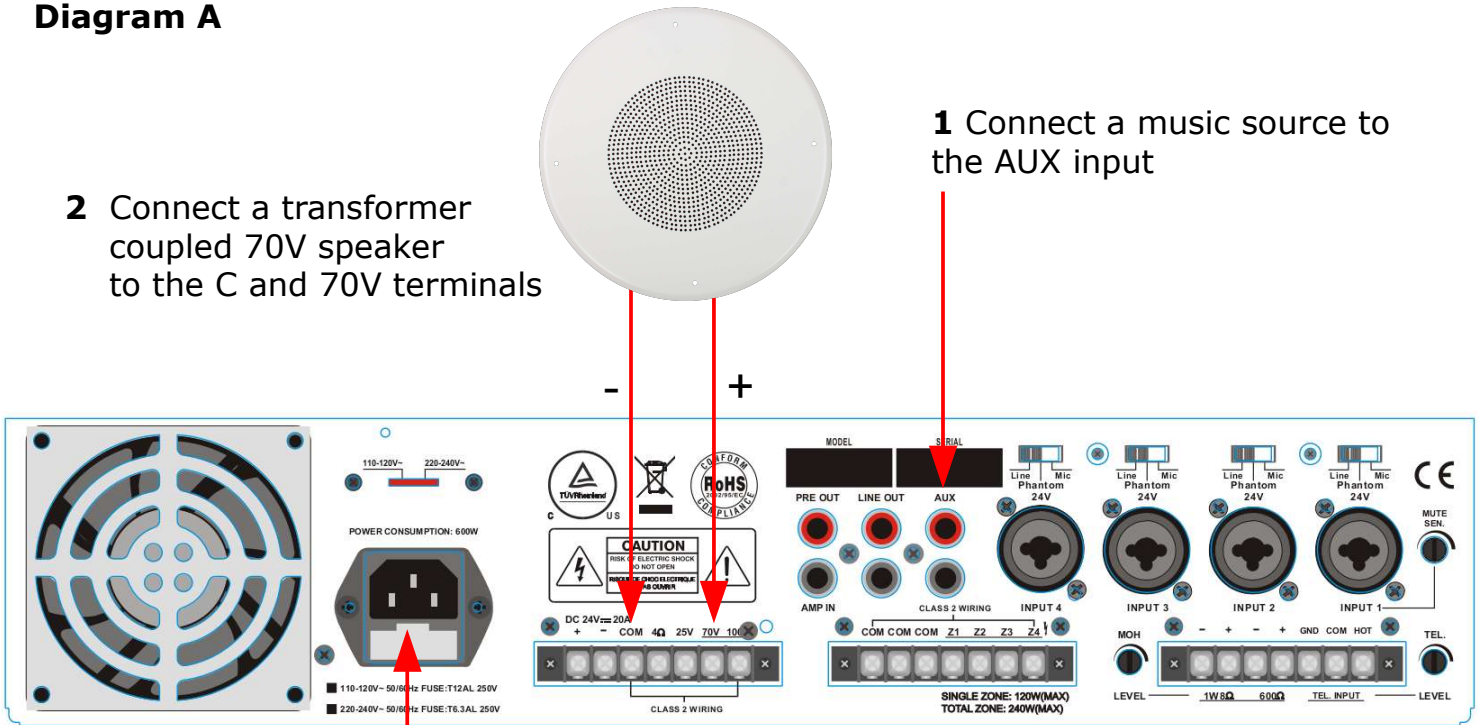

3 After all your connections are made plug the AC power cord in

6 Adjust the master volume

5 Adjust the AUX volume

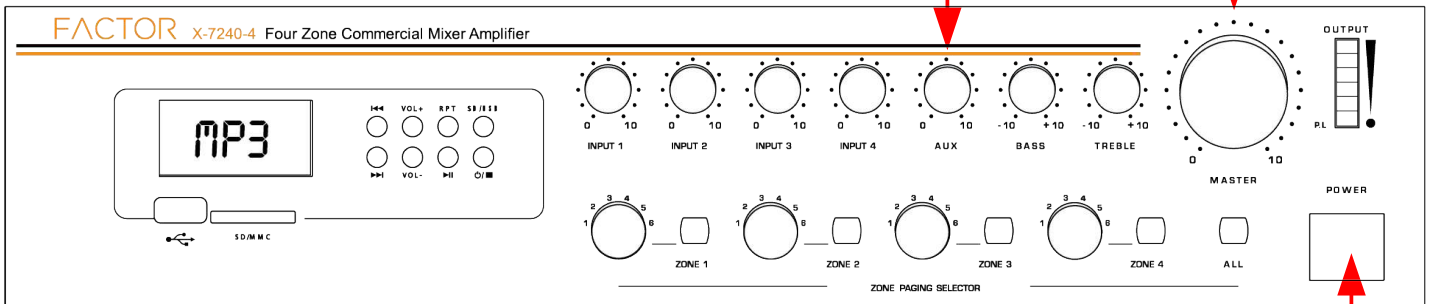

4 After all your connections are made press the power switch ON

## Front Panel Operations and Connections

**Input 1- 4** These rotary knobs control the level of Inputs 1-4 in the overall mix. A good level to begin with is the 12:00 position. Then adjust to achieve the desired level. Inputs 1-4 can be connected to dynamic microphones, condenser microphones or line level sources like CD or music Players. Always set the back panel Line/Phantom/MIC switch in the correct position corresponding To the type of connected source.

**Aux** – This rotary knob controls the level of the back panel AUX input.

Note: iPods and MP3 players have their own volume control. When using a hand held music player, start with the AUX set to the 12:00 position and use your hand held music players built in volume to adjust the level.

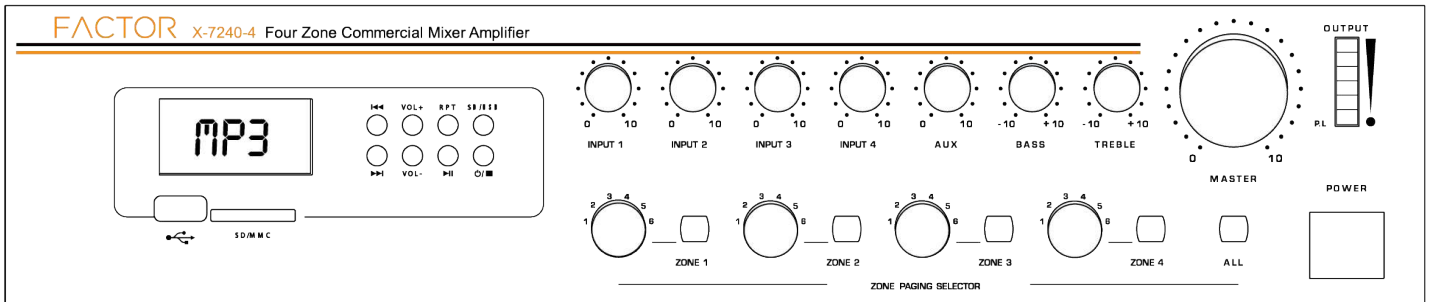

**Bass** - The bass control is a shelving type equalizer that boosts or cuts bass frequencies at 100Hz +/- 12 dB. The center "0" position does not affect the signal. Equalizers should be used sparingly. Too much boost can cause feedback when using microphones.

**Treble** - The Treble control is a shelving type equalizer that boosts or cuts bass frequencies at 10kHz +/- 12 dB. The center "0" position does not affect the signal. Equalizers should be used sparingly. Too much boost can cause feedback when using microphones.

**Master** - The Master gain control controls the overall output of the amplifier. Pay close attention to the output OL LED. The LED provides visual feedback to the levels in the amplifier. When the OL "RED" LED is lit or flashing the amplifier is being overloaded. Immediately turn down the Master volume control. Re-adjust the Input level controls to the desired mix and then adjust the Master level control to the desired volume where the OL LED is not solidly lit.

**Zones 1- 4** The zone 1-4 rotary knobs control the audio level of zones 1-4. The push buttons control the ON/OFF status of each zone. The ALL button sends audio to all zones simultaneously which is commonly referred to as ALL CALL paging. Please note that when connecting speakers to the back panel zone 1-4 outputs any individual zone can have a maximum of 120 watts / 70V (X-7240-4) and 60 watts (X-7120-4) connected and all speakers in all zones combined cannot exceed 240 watts at 70V (X-7240-4) and 120 watts (X-7120-4).

Each zone rotary volume position provides a different output voltage as follows:

1-10V, 2-22V, 3-31V, 4-44V, 5-70V, 6-100V. When using 70V transformer coupled speakers never exceed a volume setting of 5 on any individual zone. Adjust your overall system volume using the master volume control.

## Front Panel Operations and Connections

**Power** - The Power switch applies power to the amplifier.

**Output LED's** – The Output LED ladder displays the amplifier output level between ON and overload. It's good practice to keep the output level below clipping.

It's normal for the clip LED to flash momentarily with higher level program material and peaks in program material. If the clip LED lights solid the amplifier is being overloaded. This could cause damage to the amplifier and your speakers. Always keep the master volume level below clipping to ensure long term stable amplifier operation.

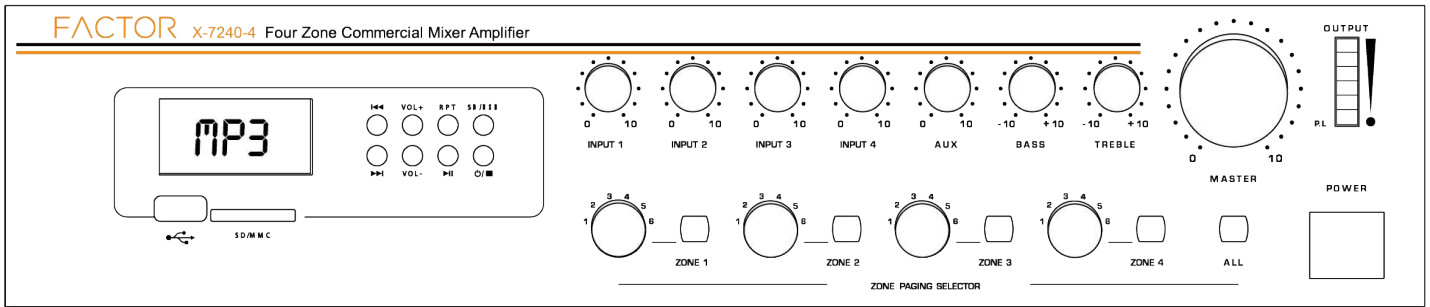

**MP3 Player** – The X-7240-4 / X-7120-4 is equipped with an MP3 player that is capable of playing Music stored on USB thumb drives or SD/MMC digital storage cards. This is an excellent way to play non-stop commercial free background music from your music library.

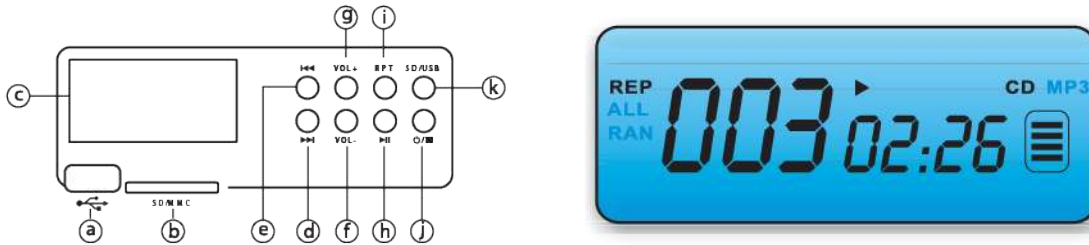

(a)	USB CONNECTOR	Insert your USB thumb drive here
(b)	SD/MMC CARD CONNECTOR	Insert your SD/MMC media card here
(c)	DISPLAY	Displays the selected track and track time
(d)	▶▶	Advance to the next track
(e)	◀◀	Go back to the previous track
(f)	VOL-	Volume down
(g)	VOL+	Volume up
(h)	▶	Play / Pause
(i)	RPT	Repeat the selected track
(j)	⏻/■	Power ON/OFF
(k)	SD/USB	Select the SD/MMC input or the USB input



## Rear Panel Operations and Connections

**Input 1** Input 1 is a priority input. This input functions the same as the other input channels but offers some added features suitable for paging microphones. Priority means “override”. Simply stated the microphone or line level signal will override all other inputs.

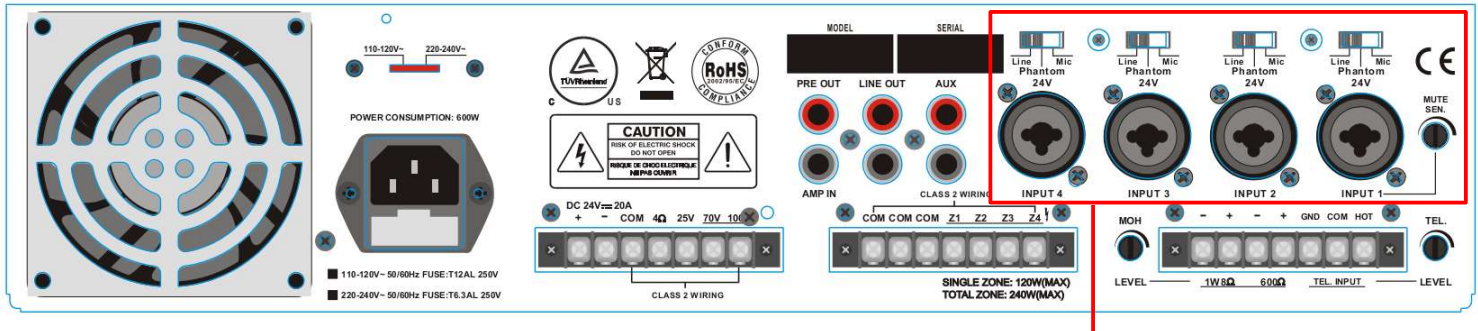

**Mute SEN** – The Mute SEN adjusts the level of override. Fully counter clockwise reduces the sensitivity where more of the background music would be heard. A high input level would be necessary to trigger the override circuit. Fully clockwise increases the sensitivity where a low input level would trigger the override circuit and the background music would be completely muted. Adjust this control to achieve your desired results.

**Inputs 2-4** – Inputs 2-4 are identical and can be used to connect Dynamic Microphones (no phantom power necessary), Condenser Microphones (phantom power is necessary), or line level sources like CD players, AM/FM tuners, DVD players, set top cable boxes or music servers (do not use phantom power). Inputs 1-4 will accept balanced XLR connectors as well as 1/4" 6.3mm type phone jacks. **Caution: always select the appropriate corresponding switch position before making connections. Applying phantom power to a line level source can cause failure to the connected source.**

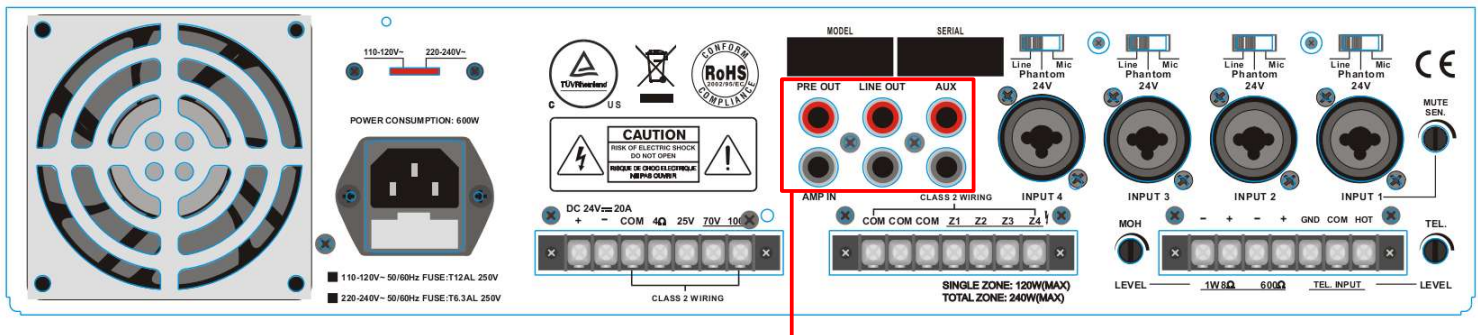

**AUX** – Connect music sources like CD/DVD players, AM/FM tuners, set top cable boxes or any line level music source here.

**Line Out** – This output sends the unbalanced pre-amplified mixed signal to other devices like additional amplifiers where more power is needed. The AUX can also be used to connect recording devices to record the pre-amplified signal.

**PRE-OUT/AMP IN** – This is a loop output/input. If the loop connector is removed the pre-amp signal from the internal mixer will not be broadcast. The amp-in is simply a line level audio input. These connectors are most commonly used to send the pre-amplified signal from the internal mixer to an audio processor like a compressor or equalizer then the processed signal is sent back into the amplifier through the AMP IN jack to be broadcast.

## Rear Panel Operations and Connections

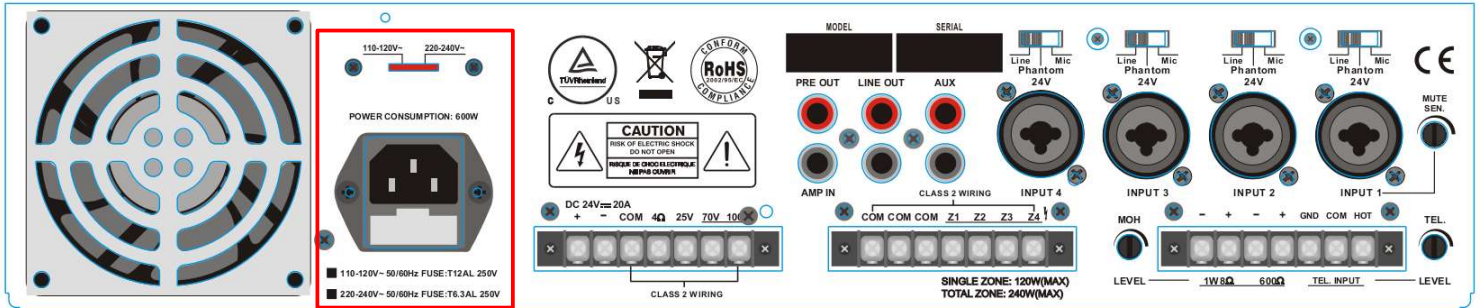

**AC Power Inlet** – Connect the supplied AC power cord in here. Only use the supplied power cord or equivalent 14awg CSA/UL approved power cord.

**AC Voltage Selector** – This slide connector changes the AC voltage from 110-120V 60Hz (North American Standard) to 220-240V 50Hz (European Standard). The unit ships with a standard North American power cord and the switch set to 110-120V. For use outside North America use a 14awg AC cord with a European type plug and change the fuse.

110-120V Fuse:T12AL 250V

220-240V Fuse:T6.3AL 250V

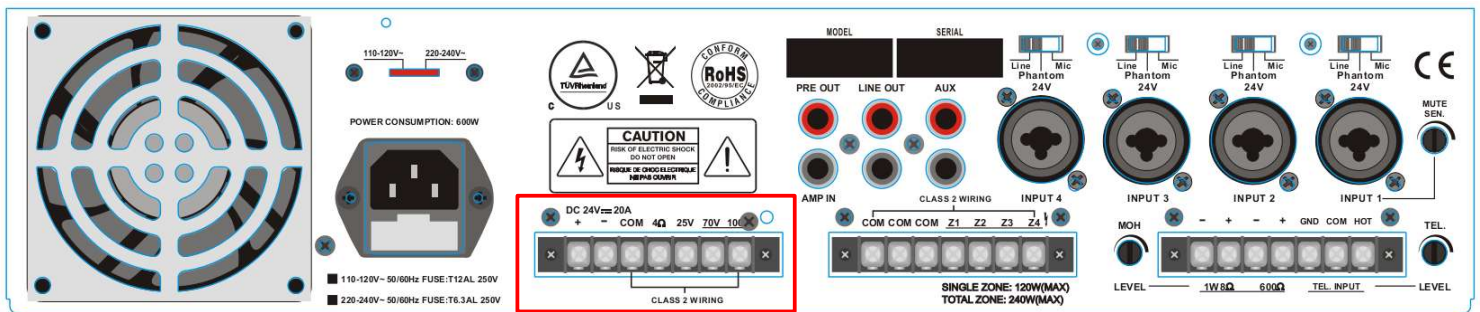

**DC 24V – 20A** – Emergency backup DC power supplies can be connected to the unit using the DC input. The DC input is polarity sensitive. Always insure the polarity of the connected power supply is consistent with the polarity of the unit.

**COM/4ohm/25V/70V/100V** – These are the speaker level output terminals. The COM or common terminal should be connected to the speaker negative -. Choose either 4ohm, 25V, 70V or 100V as the positive + to connect to your speakers. Note that all the connected speakers should be coupled to a transformer that corresponds to the output voltage. Example: 20 speakers which all have 10 watt 70V transformers. Connect the speakers in parallel. Connect the speaker – negative to the COM terminal and connect the speaker + positive to the 70V terminal. Never exceed 240/120 watts in combined speakers. We recommend that installers should maintain 30% headroom of 170/84 watts total.

**CAUTION:** Never connect 4ohm, 8ohm or 25V speakers to the 70V or 100V terminals. This can cause amplifier failure and void your warranty. If you are unsure how to connect this amplifier to your speakers call or e-mail Factor Electronics for technical support prior to making any connections. PH: 778-800-1918 [info@factorelectronics.com](mailto:info@factorelectronics.com).



## Rear Panel Operations and Connections

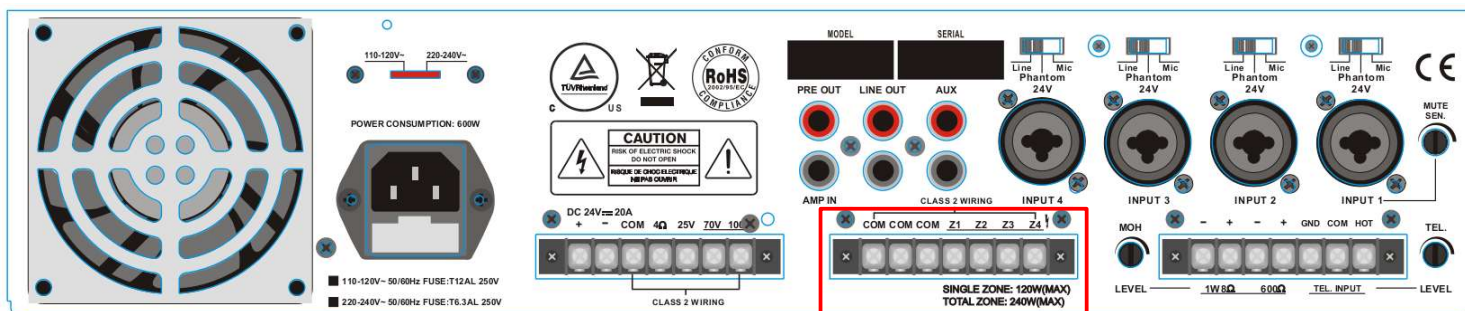

**COM Z1/Z2/Z3/Z4** – The X-7240-4 provides 4 independent output zones. The zones can be used to send background music and paging to any of the 4 zones or all zones simultaneously with the ALL button. Individual volume control is provided for each zone. The zone audio signal is taken after the pre-amplifier. All audio sources, mic or line will be broadcast in the selected zone. Connect the zone outputs exactly the same as the main outputs using the common COM as the negative – and the Z1/Z2/Z3/Z4 as the positive +. The X-7240-4 is a 240 watt amplifier. Never connect a speaker load that exceeds 240 watts in total. (ALL OUTPUTS COMBINED)

**CAUTION:** Each zone is capable of a maximum of 120 watts and a maximum of 240 watts all zones combined. Never connect more than 120 watts to any single zone.

When using 70V speakers set the front panel zone volume to 5 or less. The number 6 position provides 100V at the outputs and should not be used with 70V speakers.

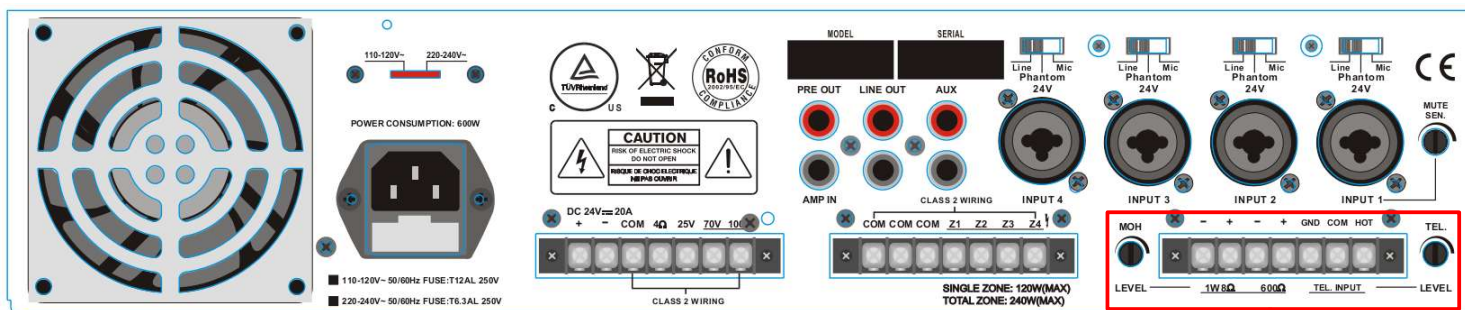

**TEL INPUT** – This is a balanced audio input that is designed to accept signals from an analog telephone output. Due to the varied output levels from different telephone systems we have provided a level control that allows precise level adjustments.

**NOTE:** The TEL INPUT automatically overrides all signals in the pre-amplifier and broadcasts the page when an announcement is made through the telephone system.

**TRANSFORMER ISOLATION** – Many telephone systems need to be physically isolated from the amplifier and can pass DC voltages from the phone system paging outputs. The X-7240-4 provides an internal transformer which blocks potentially harmful DC voltages and effectively isolates the X-7240-4 from the phone system which reduces noise.

**MOH OUTPUTS:** - MOH is Music On Hold. The X-7240-4 provides a line level 600ohm output and an 8ohm 1watt speaker level output. Carefully check the recommended input of the phone system to match the X-7240-4 MOH outputs. The 8ohm 1W output can be used to power a speaker. This is useful in lobbies and waiting rooms where the music will be broadcast but the paging will not be broadcast. The MOH input is taken from the AUX input jack and the MP3 player providing uninterrupted music for phone systems and lobbies.

# Rear Panel Operations and Connections

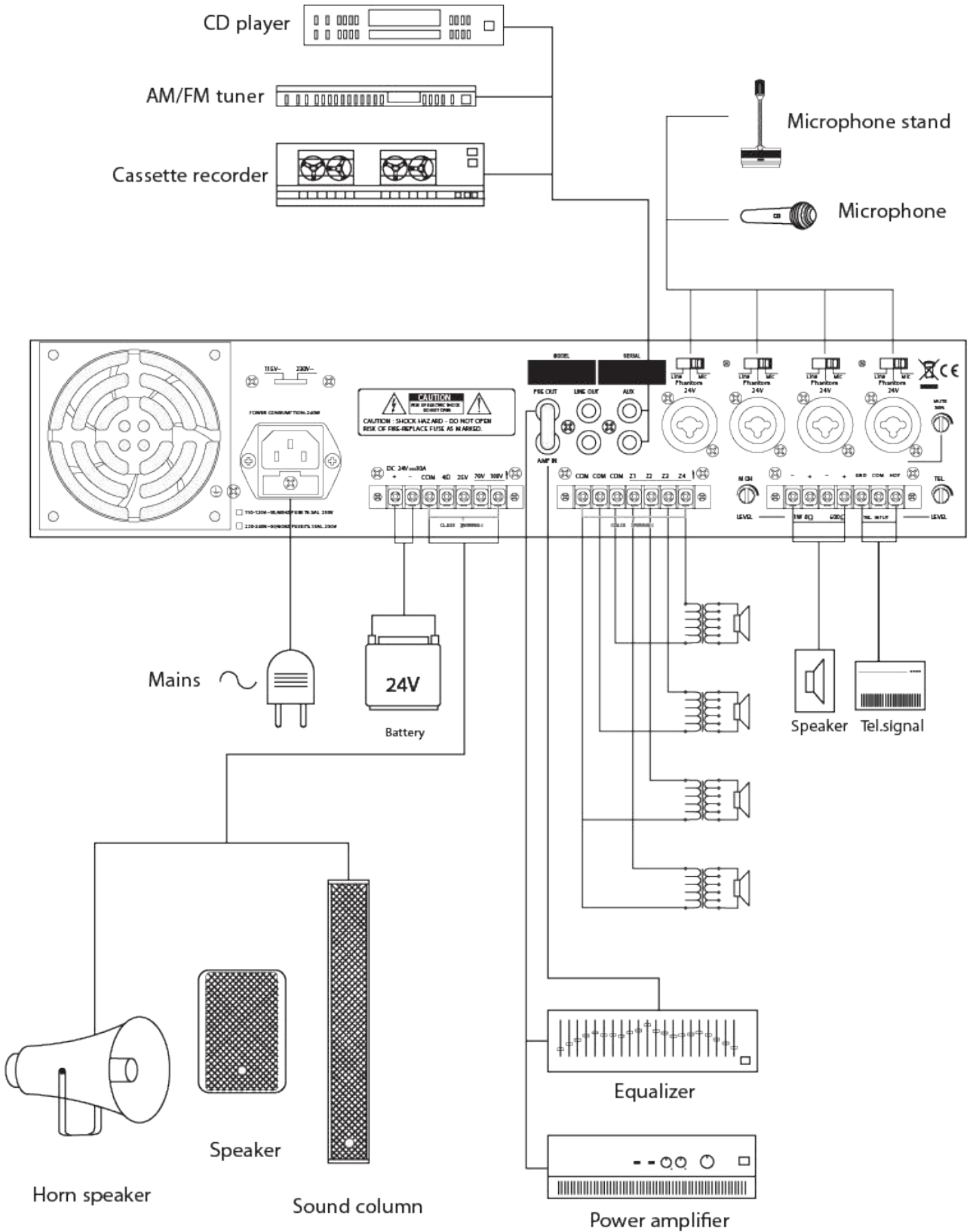

### Rear Panel Operations and Connections

**EXPAND THE INPUTS** – It is possible to expand the inputs of the X-7240-4 using the V-RVC-PRO (remote mic/line mixer) and the X-Music (in-wall iPod Smart Phone dock). The V-RVC-PRO is capable of expanding the X-7240-4 inputs to a maximum of 12 over Cat5/6 cable. See the diagram below.

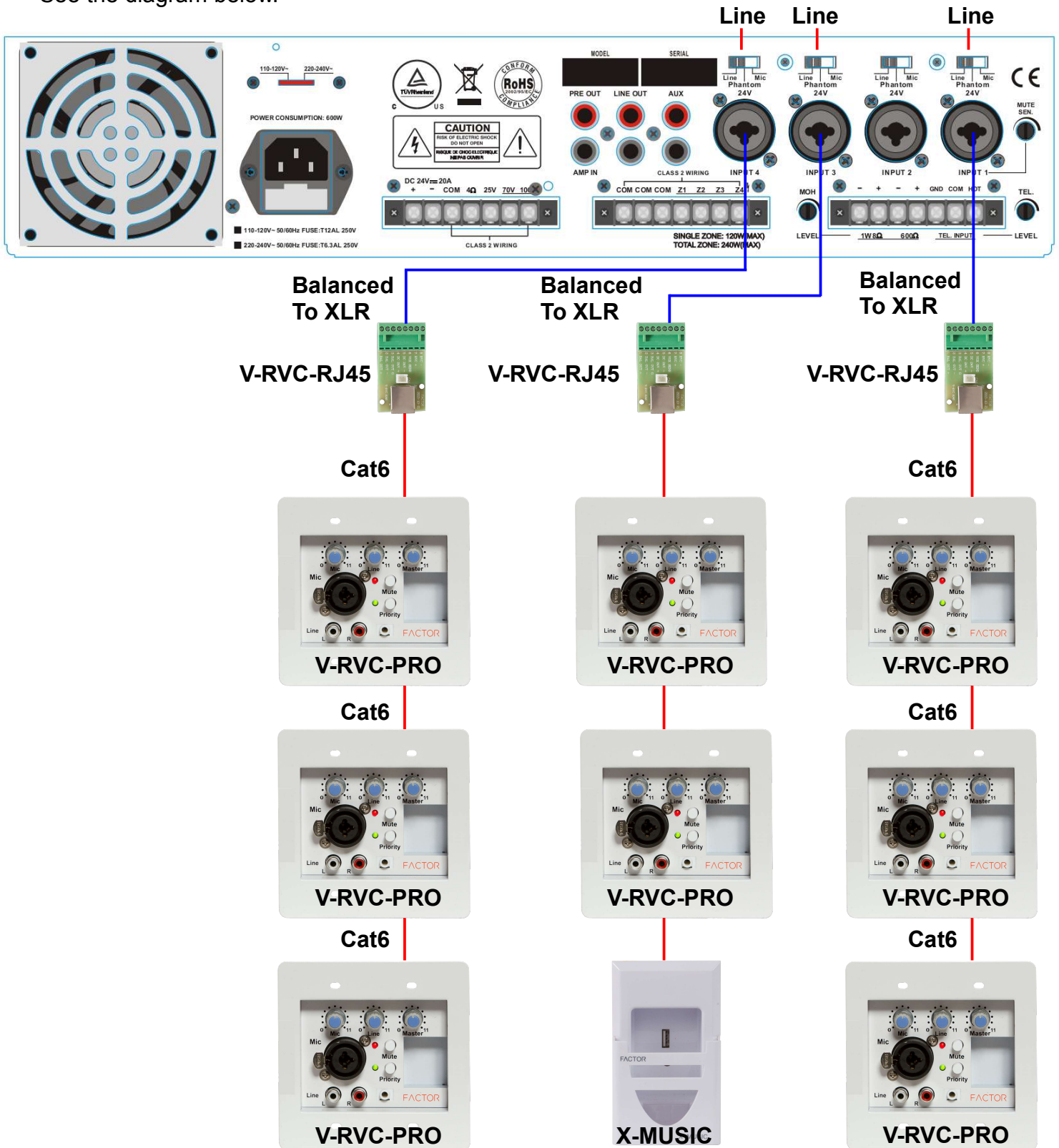

RMS output	AC:120W/ 240W; DC:88W/165W
Frequency response	80Hz-16kHz( ±3dB)
T.H.D.	≤ 1%
S/N Ratio	MIC: ≥65dB Phantom: ≥ 65dB Line: ≥ 75dB AUX: ≥80dB
Power consumption	AC110-120V / AC220-240V: 285W / 600W; DC 24V: 10A / 20A
Input/Sensitivity	Mic : -52dBV balanced Phantom : -52dBV / 24V balanced Line : -10dBV unbalanced Aux : -6dBV unbalanced AMP IN : 0dBV unbalanced; TEL IN : -10dBV balanced
Output	COM , 4 Ω , 25V , 70V , 100V
Zone out	Z1 ~Z4 : 100V
Controls	4 Input volume controls; 1 Aux volume controls 2 Treble/Bass controls; 1 Master volume control 4 Zone out volume controls; 5 Zone out selector switch(units with "S") 3 REC selector switch(models of recording functions)
BGM module	MP3 PLAYER  MON/TEL
Dimensions(WxDxH)	420 x 260 x 88mm
Weight	10.2kgs X-7120-4                      11.0kgs X-7240-4



**Warranty**

Factor Electronics amplifiers are warranted to be free from defects in workmanship and materials for a period of three (3) years from the date of purchase without charge for parts or labour. This warranty applies only to the original owner. The owners responsibilities are to provide proof of purchase from an authorized Factor Electronics dealer/distributor and transportation to the dealer/distributor the unit was purchased from or Factor Electronics. This warranty does not apply to units that have been subject to misuse, abuse, neglect or improper installation, and does not apply to repairs or alterations made by unauthorized personnel. This warranty specifically excludes responsibility for consequential damage. Retention of your original bill of sale is required to obtain service under the terms of this warranty.

**Contact Information:** Factor Electronics, 4159 McConnell Drive Burnaby B.C. Canada V5A-3J7  
PH: 778-800-1918 E-Mail: [info@factorelectronics.com](mailto:info@factorelectronics.com) Web: [www.factorelectronics.com](http://www.factorelectronics.com)

In an effort to constantly provide our valued customers with the latest advancements in technology, Factor Electronics specifications are subject to change from time to time without notice.