

FULL MOTION DUAL STUD MOUNTS

PMX660



Defy gravity.

Don't let the size of your TV dictate where you put it. Capable of supporting TVs up to 80", the PMX660 features two articulating arms that can be horizontally offset to give you the utmost discretion over where your TV is placed. With 22" of extension, this full motion wall mount provides enough tilt and swivel movement to ensure you always have the perfect viewing angle. Its low profile design allows your TV to sit 2.5" from the wall when fully retracted and features cable management clips to keep your cables out of sight.

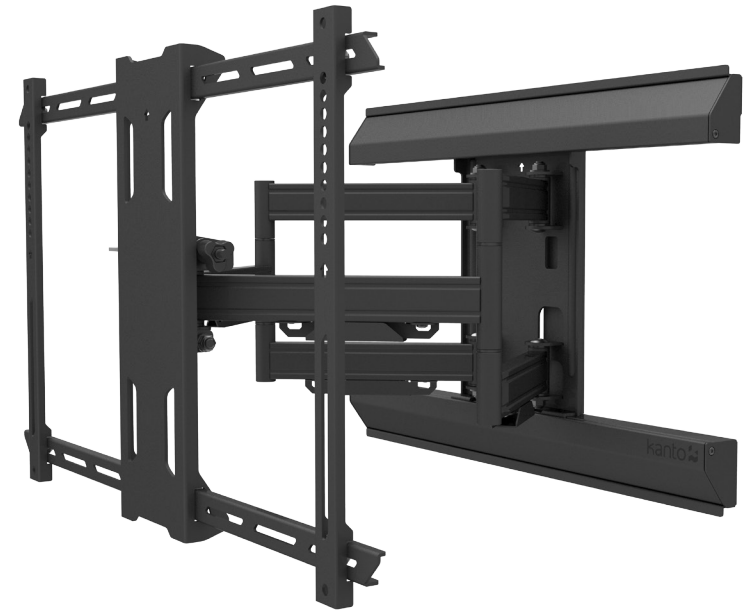

FEATURES & SPECIFICATIONS

- Fits most flat panel TVs from 37" to 80"
- Supports TVs up to 125 lb (57 kg)
- Accommodates VESA sizes from 200x100 to 600x400
- Accessible tilt mechanism provides a +12° to -3° tilt angle
- Up to 90° of swivel in either direction, depending on screen size
- Sits 2.5" (6.3 cm) from the wall
- Extends up to 22" (55.9 cm) from the wall
- +/- 6" (15.2 cm) of horizontal offset
- Adjustable horizontal leveling
- Integrated cable management
- 23.2" (59 cm) dual stud wall plate accommodates up to 16" stud spacing
- Solid steel construction with durable powder coated finish
- Installation manual and all mounting hardware for wood stud and concrete installation is included
- cULus Certified
- Ten year warranty

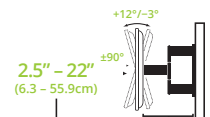
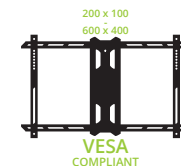
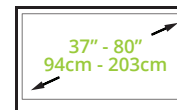

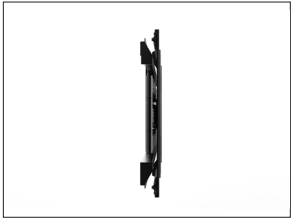

LOW PROFILE DESIGN

The PMX660's low profile design allows your TV to sit 2.5" (6.3 cm) from the wall when fully retracted.



EXTENDS 22 INCHES

Easily reach over fireplaces or out of recessed locations with 22" (55.9 cm) of extension.



SUPPORTS 125 POUNDS

The PMX660's solid steel frame safely holds up to 125 lb (57 kg), even at full extension.

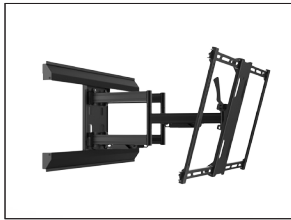

15 DEGREES OF TILT

Effortlessly tilt your TV 12° forward or 3° backward with the PMX660's toolless tilt mechanism.



WIDE RANGE OF SWIVEL

Two wishbone-style arms provide up to 90° of swivel in either direction, depending on screen size.

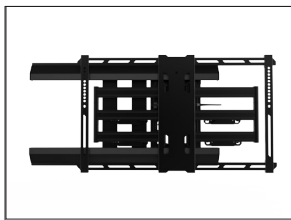

HORIZONTAL OFFSET

Center your TV on the wall regardless of where your studs are located by adjusting the PMX660's arm assembly 6" (15.2 cm) left or right.

TECHNICAL ILLUSTRATIONS

